

TECHNICAL BULLETIN

Volume 2 - Issue 1 • Winter, 2018

ECLIPSE 12-100

NEW PRODUCT TECHNOLOGY

The new Eclipse 12-100 features a one-piece, heavy duty steel casting machine frame that is 2m in diameter, nearly twice as large as the traditional 12 station Hydromat machine. This machine platform offers multiple tool spindles in a single footprint integrated with one chip management & coolant system. Robot load/unload with auto inverting offers six-sided machining capability on both bar and blank loading applications.

Each of the 12 tool spindle modules features 3-axis or 4-axis capability with all electric servo spindles and high-tech components such as heavy-duty linear guideways for high accuracy, and large bearing diameters for extra stability, that yield smoother cutting at higher speeds. Designed to be exceptionally rigid, these modules were designed with beefy castings for superior vibration dampening properties and maximum precision.

The Eclipse offers a high degree of machining flexibility derived through engineering expertise coupled with a visionary concept, the type of creative thinking that has produced this superior Rotary Machining Center for small to large batch production.

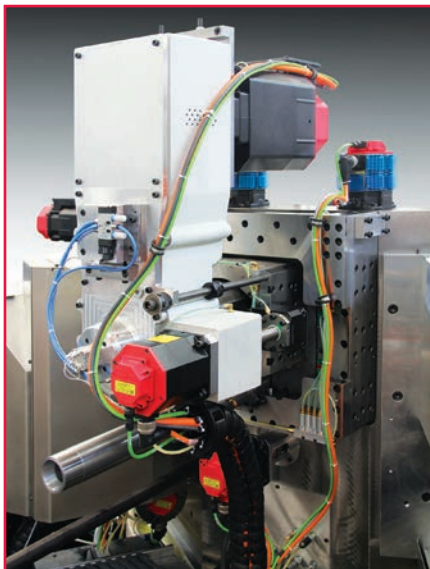
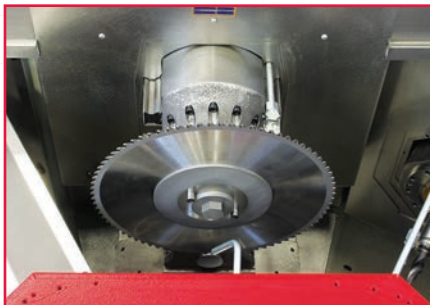
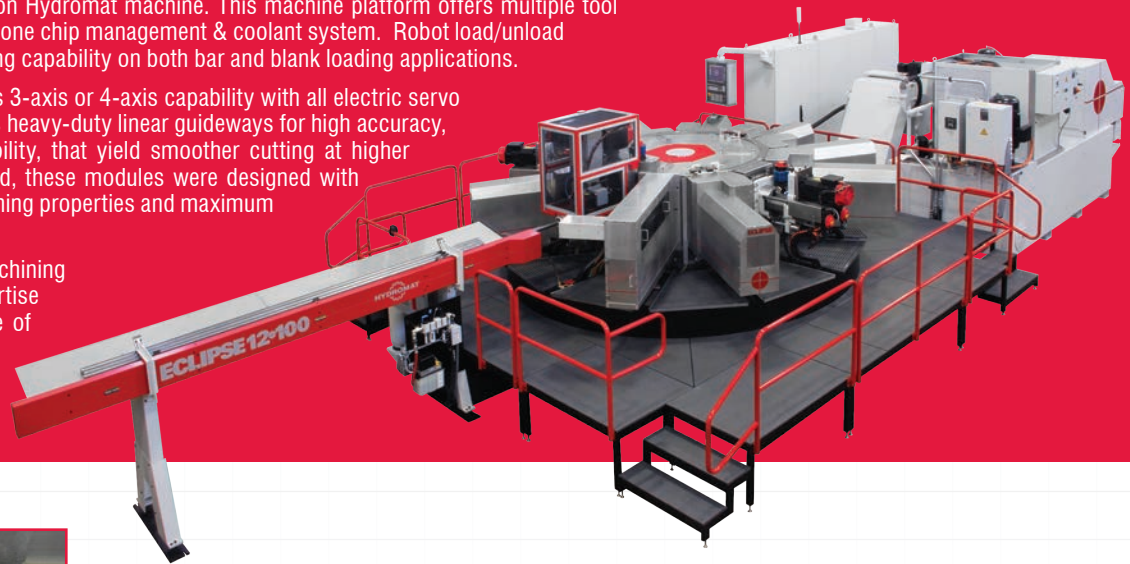

ECLIPSE 12-100 Rotary Transfer Machine

- Heavy duty cast iron base with 12 horizontal positions and 100mm (Chucks) work-holding capacity
- FANUC 30iB CNC control and touch screen operator pendant interface
- Index Table equipped with Hirth Ring coupling providing indexing accuracy and repeatability
- Quick change Hainbuch collet and chuck table clamping systems
- Vertical Sliding Cut-Off Saw module
- Standard all electric 3 and 4-Axis tool spindle modules

FANUC CNC Control

- FANUC 30iB CNC Control with 15" Panel I touch screen
- Remote hand held operator display unit with jog buttons and emergency stop functions
- Encoder servo feedback system
- High speed cutting and rigid tapping options

ECLIPSE Cut-Off Saw Module

- Vertical slide motion to position saw blade above the bar stock and eliminate remnants damaging the blade
- 3-Axis with direct drive dual winding servo spindle motor
- Bar and workpiece spacing during saw retract motion eliminates saw blade dragging on return motion
- Standard carbide tipped Ø 360mm saw blade
- 80mm Y-axis and 135mm Z-axis stroke
- 500rpm base speed / maximum of 6,000rpm

HYDROMAT INC. • ADVANCED MACHINING SOLUTIONS



Index Table

- 12 hydraulic actuated Hainbuch stationary Quick Change clamping devices with 65mm maximum clamping capacity with hexagon draw type clamping geometry
- Quick Change 2 or 3 jaw chuck system 100mm maximum clamping capacity
- Table index 0.9 seconds
- Hydraulic actuated lift and down function
- Servo hydraulic single or double index function
- HB45 Collet - Ø 40mm / Hainbuch Collet - Ø 65mm

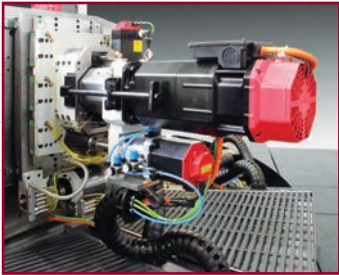
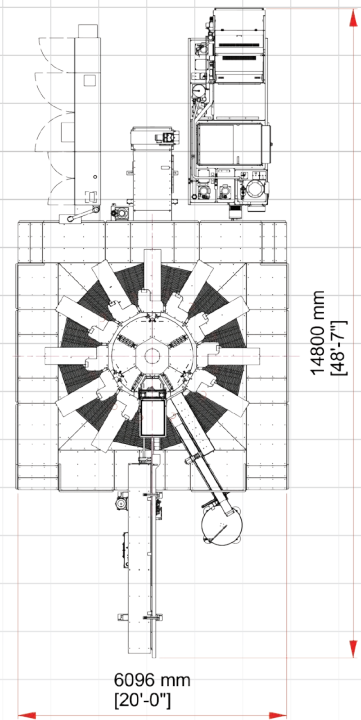

ECLIPSE 55/250 3-Axis Toolspindle Module

- Direct drive spindle motor with Ø 55mm front bearings with 250mm Z-Axis stroke
- 80mm X-Axis and 100mm Y-Axis CNC slide stroke
- FANUC 8,000 or 12,000 RPM servo motor
- HSK-C50 tool holder interface
- Optional coolant fed

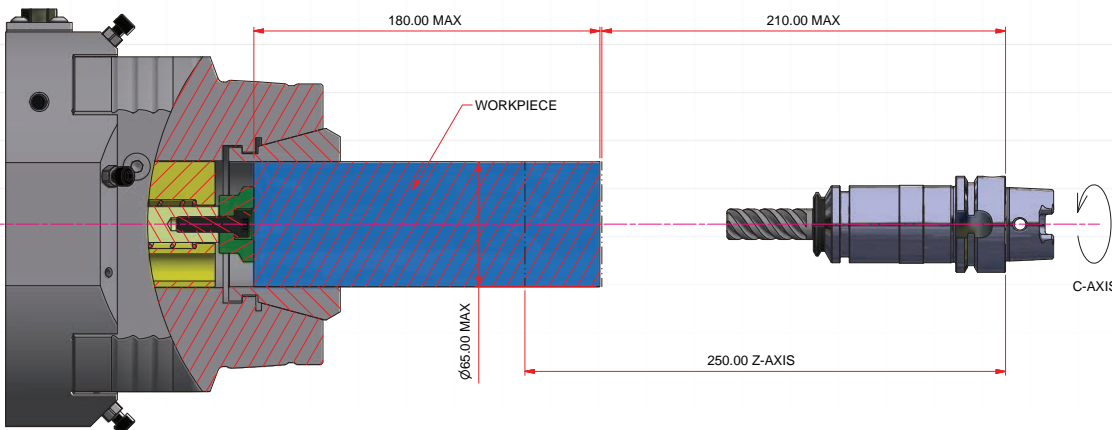

ECLIPSE 55/250 4-Axis Profile Toolspindle Module

- Belt driven spindle with Ø 55mm front bearings and a 250mm Z-Axis stroke
- 80mm X(1)-Axis and 100mm Y-Axis CNC slide stroke
- FANUC servo motor
- Flange spindle for mounting dynamic profile turning head with 30mm X(2)-Axis stroke
- Ø 160mm dual or single slide profiling head -5,000 rpm

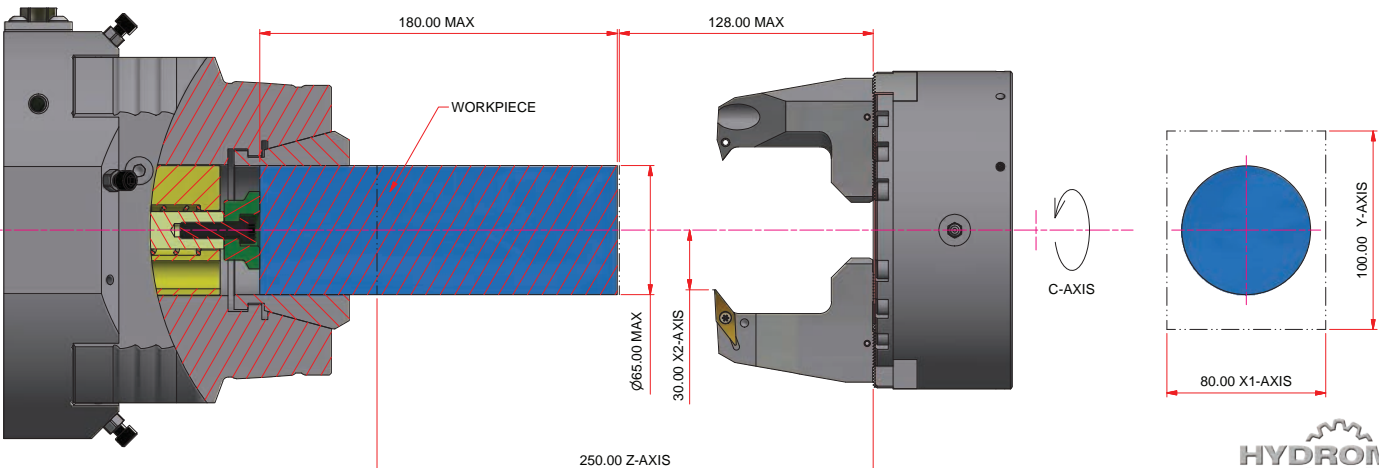

HYDROMAT INC. • ADVANCED MACHINING SOLUTIONS

